

Features:

- Combined AC and emergency LED driver in one compact
- EN61347-1, 61347-2-7, 61347-2-13
- Built-in lithium battery
- Battery protections : over charge protection、over discharge protection 、short circuit protection
- Indicator shows a variety working modes
- The batteries Meet 300 cycles of standard CH and standard DCH
- No flicker
- RoHS compliant



CE RoHS

Specifications:

Universal Input Voltage
200 - 240Vac, 50/60Hz

Output Voltage
30-42Vdc

Operating Ambient Temp Range
0°C to +40°C (32°F to 104°F)

Full Warranty
3 Years

Dimensions
8.66"x3.9"x1.18" (220mmx100mmx30mm)

Weigh
1.63lbs(0.74kg)

AC Operation:

Output Current(Programmable)
800mA

AC Input Current
600mA max.

Maximum Input Power
30W max.

Power Factor@Max Load
≥0.90

Surge Protection
(Combi-Wave, KV)
1.0KV

Dimming
0-10Vdc

Emergency Operation:

AC Input Current
100mA Maximum (Charging Only)

AC Input Power Rating
6.0W Maximum (Charging Only)

Recharge Time
≥24 Hours

Battery
lithium battery

Battery Charging Current
350mA max.

Output Power
6W (Emergency)

Illumination Time
≥3H

Test Switch Charging Indicator Light
Illuminated Test Switch

Dimensions:

8.66"x3.9"x1.2" (220mmx100mmx30mm)

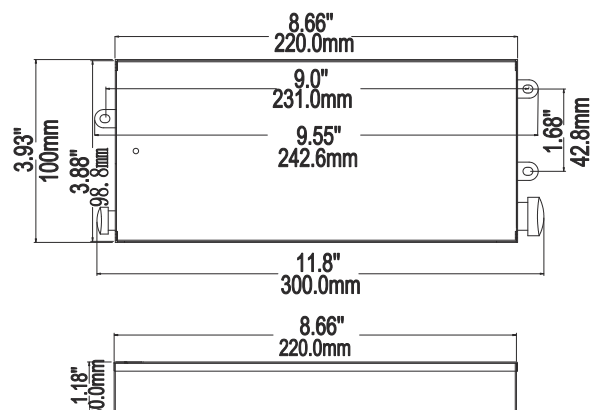

Wiring Diagram:

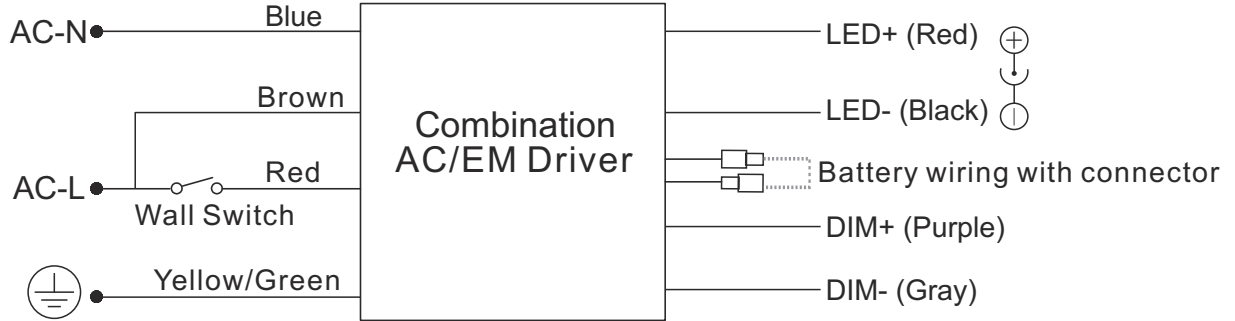

1. The power supply cannot insert the battery packet into the mainboard connector before installation; It has been installed to allow the battery package to be inserted into the mainboard connector before the AC voltage is completed.
2. Test accessory leads-observe proper polarity wiring.

Display Status:

Operating Condition	Red	Green
Charging	ON	OFF
Emergency	OFF	ON

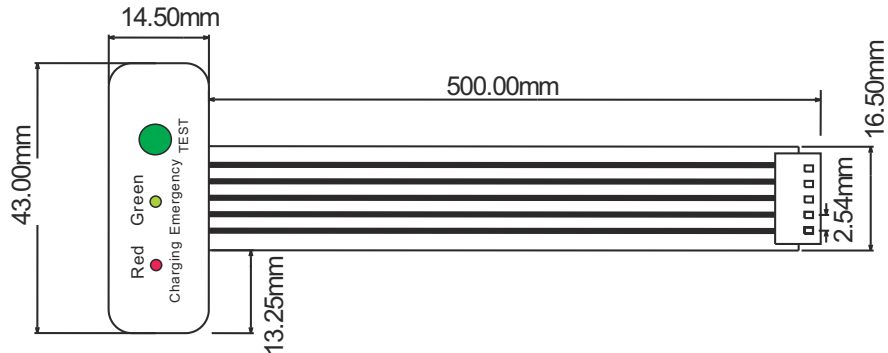

Safety Instructions:

- Risk of fire or electric shock. Luminaire wiring and electrical parts may be damaged when drilling for installation of LED emergency driver. Check for enclosed wiring and components.
- Risk of fire or electric shock. This LED emergency driver installation requires knowledge of luminaires electrical systems. If not qualified, do not attempt installation. Contact a qualified electrician.
- Before installing, make certain the AC power to the fixture is off.
- The electrical rating of this product is 200–240Vac, installer must confirm that there is 200–240Vac the fixture before installation.
- To prevent electrical shock, only mate unit connector after installation is complete and before the AC power to the fixture is back on.
- Do not use outdoors.
- This LED emergency driver unit requires an un-switched AC power source of 200–240Vac, 50/60Hz. The AC driver must be on the same branch circuit as the LED emergency driver unit.
- Do not let power supply cords touch hot surfaces.
- Do not mount near gas or electric heaters.
- Do not join battery pack connector until all other wiring is complete and AC power is on.